

BAYTINA SMART TOILET

INSTRUCTIONS FOR USE AND INSTALLATION



Foshan Beitina Technology Co.,LTD.

ADD: No. 7, Floor 1, Building 18,
Casa Ceramics and Sanitary wares Mall,
Jihua 4th Road, Chancheng District, Foshan City,
Guangdong Province, China

Made in china

Baytinabathroom@gmail.com

The company reserves the right to interpret this instruction manual. If there are changes to products and technical parameters without further notice, please refer to the latest version of the instruction manual.

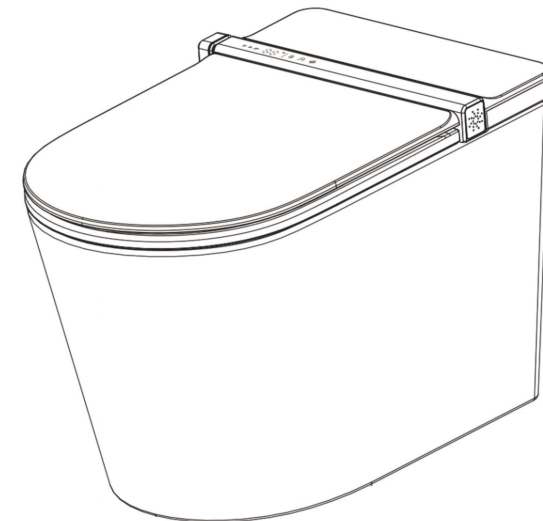

Model: TINA-R







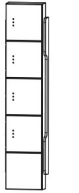

PRE-READING INSTRUCTIONS

1. Please read this manual carefully before installation and use;
2. The appearance of the product is subject to the actual..
3. For product functions, please refer to the configuration of the model actually purchased.
4. Please keep the instruction manual properly and take it out to read when necessary.

PTABLE OF CONTENTS

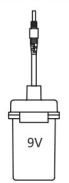
1. Accessories List	2
2. Tools Preparation	2
3. Product Introduction	3
4. Safety Precautions	4~6
5. Precautions before Installation	7~8
6. Installation Steps	9~10
7. Remote Control Operating Instructions	11~12
8. Knob Operation Instructions	13
9. Troubleshooting	14
10. Maintenance	15~16
11. Product Specifications	17
12. Instructions on Environmental Protection, Energy Efficiency and Water Efficiency	18

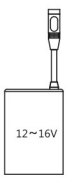
1 - ACCESSORIES LIST

<p>Generic accessories</p>  <p>Sealing ring</p>  <p>Remote control and wall mount bracket</p>  <p>Instructions and other documents</p>  <p>Remote control batteries (AA type) X2</p>  <p>Expansion screws for remote control X2</p>	<p>Accessories for Model without Tank</p>  <p>Water Valve : Inlet 1/2 inch , Outlet 1/2 inch and 3/4 inch.</p>  <p>9V Battery Pack</p>	 <p>Foam Liquid(450ml)</p>
<p>Accessories for Model with Tank</p>  <p>Water Valve : Inlet 1/2 inch , Outlet 1/2 inch</p>  <p>12~16V Battery Pack</p>	<p>Accessories for Model with Aromatherapy</p>  <p>Aromatherapy tablets (15x5mm)</p>	

2 - TOOLS PREPARATION



3 - PRODUCT INTRODUCTION

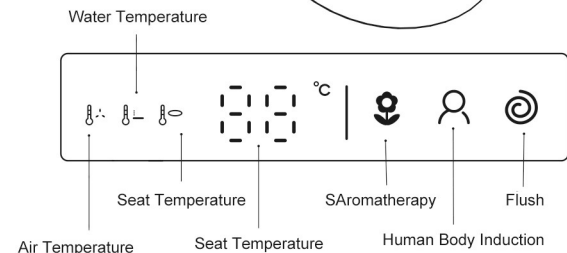
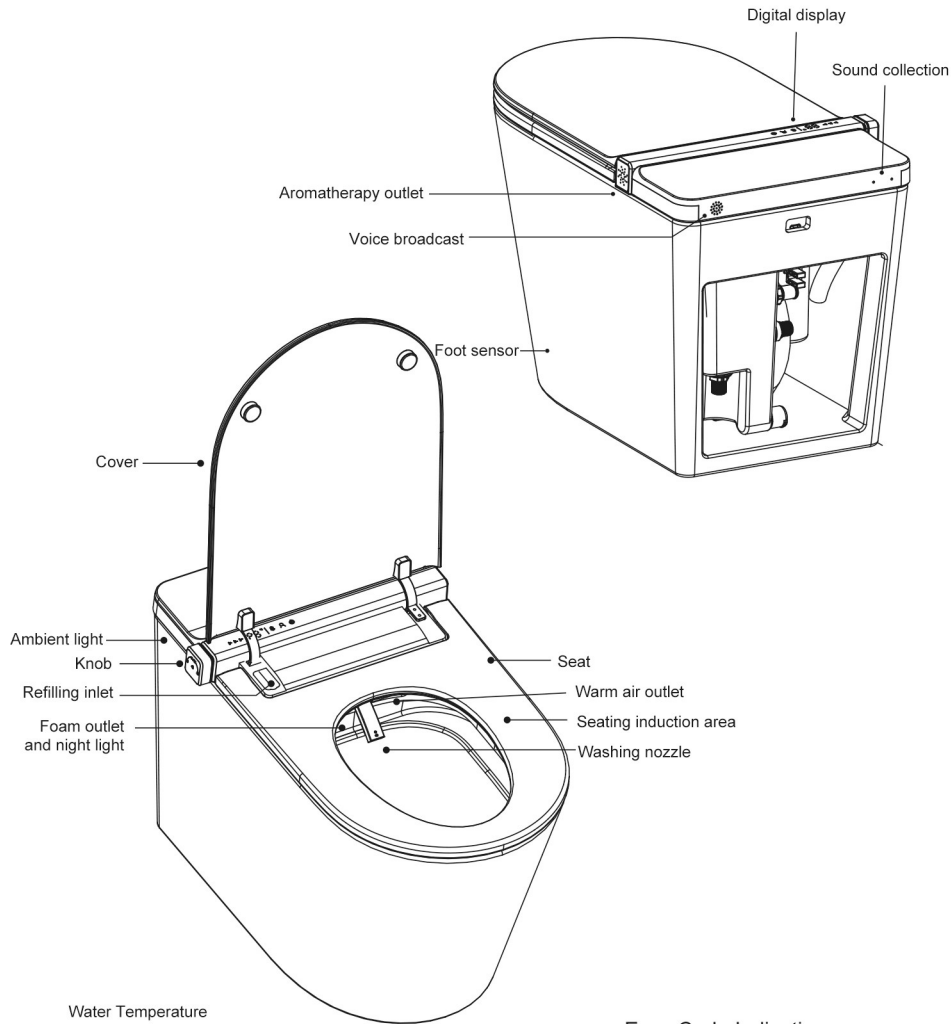

Error Code Indication

- E1 Seat temperature sensor failure
- E2 Seat over temperature
- E3 Air temperature sensor failure
- E4 Water temperature sensor failure
- E5 Water flow sensor failure
- E6 Water over temperature
- E7 Communication failure between main board and sub board

4 - SAFETY PRECAUTIONS

Precautions before installation (for safety purpose, please be sure to follow them)

The following precautions are closely related to safety and may have major consequences depending on the situation, so please be sure to abide by them.



Warning Means that if you ignore this sign and operate incorrectly, Person injury or death may occur.



CAUTION Means that if you ignore this sign and operate incorrectly, Person injury or property damage may occur.







- The Power socket should be used within the prescribed range. If over the specified range, it will cause the socket heat up and cause a fire.
- The power socket must be equipped with earth wire. Please leave wiring installation to the electrical installation company. Do not plug in power cord into the socket before installation is completed to avoid error.
- Danger! There is a risk of electric shock. Cut off the power supply before operation.
- Caution! Before installing the product, please close the main water inlet valve to avoid water leakage and property damage.
- Caution! There is a risk of harmful gases. If the smart toilet cannot be installed immediately, you can temporarily cover the sewage outlet on the ground with a cloth.











- Comply with all local plumbing and electrical codes . Power and water pipes should be wall mounted.
- The length of power cord is approximately 1.5 meters. Install the power socket within the reach area of power cord . Socket should be higher than floor where it will not be easily wet by water.
- Inspect the smart toilet carefully to check is there any damage.
- In winter, when the product is transported over long distances or stored for a long time, the remaining water in the product may freeze. In order to prevent damage caused by freezing, the product must be placed in a warm room for 30 minutes to allow it to defrost naturally before installation as well as water and electricity connection.

Note: Above parts are just one of the appearance for smart toilet. Different models may have slightly different appearance and functions. Please refer to the actual product.





4 - SAFETY PRECAUTIONS

 Warning	
 Must be obeyed	<ul style="list-style-type: none"> ● Caution : Low Temperature Burns <ol style="list-style-type: none"> 1. When sitting on the seat for a long time, please setup the seat temperature as normal temperature. 2. When the following people use the product, please setup the seat temperature as normal temperature. The elderly and children who cannot adjust seat temperature by themselves. Disabled or patients who are limited mobility. People with drowsiness who have taken sleep-promoting drugs (such as sleeping pills, cold medicine, etc.), drank heavily and were overtired. ● Make sure the power plug is inserted in place. If it is not fully inserted, it may cause electric shock or heat and cause a fire. ● Be sure to disconnect the power supply when cleaning.
	<ul style="list-style-type: none"> ● Do not plug or unplug the power plug with wet hands, otherwise it may cause electric shock.  ● Do not continue to use the product if it malfunctions In the following situations, please unplug the power plug and close the water inlet valve. ● Do not damage or replace the power cord, power plug and connecting cable without permission. <ol style="list-style-type: none"> 1. If it is still used if it is damaged, it may cause electric shock, short circuit, or fire. 2. The power cord of this product adopts Y-shaped connection. If the power cord is damaged, it must be replaced by our company or professional service person authorized by our company. ● Do not use other water sources other than tap water <ol style="list-style-type: none"> 1. Otherwise it will cause problems such as dermatitis. 2. If foreign matter is mixed in and accumulated inside it, which may cause malfunction. ● Patients with pacemakers should not use this product. Otherwise, electromagnetic interference will be generated, which may damage the function of the pacemaker and cause life-threatening consequences. ● Do not put lit cigarettes into the toilet or place hot or flammable objects near the toilet. Otherwise it may cause fire.   Forbidden High Temperature ● This product should not be used by persons with reduced physical, sensory or mental capabilities, or lack of experience and knowledge(included children). Unless they have been supervised or instructed in the use of the product by a person responsible for safety. Do not let children play on the seat or cover. Do not step on or sit on the cover. Otherwise, it may cause malfunction and safety accident.

4 - SAFETY PRECAUTIONS

 Notice	
 Forbidden	<ul style="list-style-type: none"> ● Do not sit on cover, otherwise the cover may be damaged.  ● Do not leave the product under strong light or direct exposure to sunlight for a long time, otherwise it will cause discoloration of plastic parts and unstable seat temperature.  ● Please do not impact the ceramic bowl to prevent damage and leakage. ● Do not bend or twist the water supply pipe, otherwise water leakage may occur due to loose connections. ● Do not flush other things other than excrement and toilet paper, otherwise it will cause the toilet to become clogged, sewage to flow out, and indoor water leakage . ● When closing the cover or seat, do not use excessive force otherwise the product may be damaged.
	<ul style="list-style-type: none"> ● Before taking out the filter inside the water valve, the water valve must be closed first, otherwise it will cause water leakage. ● Once the filter of valve is taken out, it must be tightened when reinstalling it, otherwise it will cause water leakage. ● When the toilet is clogged, firstly cut off the power, and then use pipe dredger to clear it. (If the power is not cut off, the automatic flushing will continue to work, which causes sewage overflow, indoor water leakage, etc.) ● When the room temperature is low (zero Celsius degrees and below), please increase the room temperature. Otherwise, the water pipes and products will be damaged due to freezing, resulting in water leakage. ● Do not wipe the product body with dry cloth or toilet paper, otherwise it may cause scratches on the product.
	<ul style="list-style-type: none"> ● Do not use it when electric outage or water outage, otherwise the product functions will not be implemented and use will be affected. ● It is strictly prohibited to move the product by the cover, otherwise it may cause mechanical failure. ● Do not pour urine on the toilet body and nozzle, otherwise it may cause malfunction or cause pink or brown stains.  ● During thunder, please unplug the power plug, otherwise it may cause malfunction.  ● When traveling or not using it for a long time, please cut off the water and electric, otherwise it may cause safety accidents. 
	<ul style="list-style-type: none"> ● Must be obeyed 

5 - INSTALLATION PRECAUTIONS

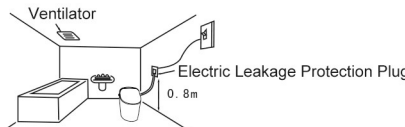
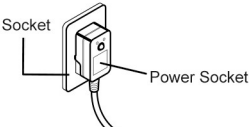
 Disassembly is prohibited	<ul style="list-style-type: none"> ● Never disassembly or modify the product, otherwise it may cause fire, electric shock, and damage by abnormal movement.
 No water splashing	<ul style="list-style-type: none"> ● Do not pour water on the product and plug, otherwise it may cause fire or electric shock. 
 Must be obeyed	<ul style="list-style-type: none"> ● This product is an electrical product, so please do not place it in a place that is easily splashed by water or has high humidity. When using it in the bathroom, please install a ventilation fan to maintain good air circulation in the bathroom. Otherwise, it may cause fire or electric shock.
	<ul style="list-style-type: none"> ● Please set the socket for the power cord as follows. Failure to follow the requirements may cause fire or electric shock. <ol style="list-style-type: none"> 1. The rated power of the socket must be higher than 2KW. 2. The socket should be installed higher than 0.8m above the floor and as far away from the bathtub or shower as possible. <div style="display: flex; justify-content: space-around; align-items: center;"> <div data-bbox="336 718 739 845">  <p>Ventilator Electric Leakage Protection Plug 0.8m Power Socket</p> </div> <div data-bbox="761 718 1008 845">  <p>Socket Power Socket</p> </div> </div> <ul style="list-style-type: none"> ● Do not use loose or faulty sockets, as this may cause fire or electric shock.

Water Supply Conditions

For Model without Tank

1. The water pressure for flushing should be $>0.15\text{MPa}$ (1.5kgf/cm^2), and the flow rate should be $>17\text{L/min}$
 2. The water pressure for cleaning should be $>0.075\text{MPa}$ (0.75kgf/cm^2). The flow rate should be $>1\text{L/min}$
- If above conditions are not met, the corresponding functions can't be achieved normally:
when other products such as faucets are used at the same time, the conditions must also be met.

For Model with Tank

1. The water pressure for flushing should be $>0.03\text{MPa}$ (3kaf cm^2)
2. The water pressure for cleaning should be $>0.075\text{MPa}$ (0.75kgf/cm^2) and the flow rate should be $>1\text{L/min}$.

If above conditions are not met, the corresponding functions can't be achieved normally:
when other products such as faucets are used at the same time, the conditions must also be met.

Installation Space Confirmation

- If drain outlet spacing is from 240mm to 280mm, it is recommended trap 250mm toilet;
- If drain outlet spacing is from 290mm to 380mm, it is recommended trap 305mm toilet;
- If drain outlet spacing is from 280mm to 290mm, select the shift flange to install trap 305mm toilet.
- If drain outlet spacing is more than 390mm, it is recommended trap 400mm toilet.
- If drain outlet spacing is from 380mm to 390mm, select the shift flange to install trap 400mm toilet.

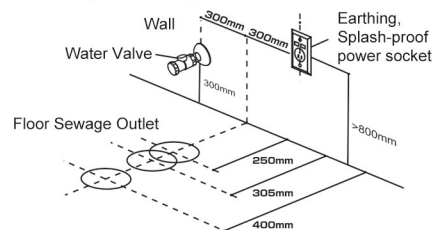

5 - INSTALLATION PRECAUTIONS

PRODUCT DIMENSION

Unit: mm

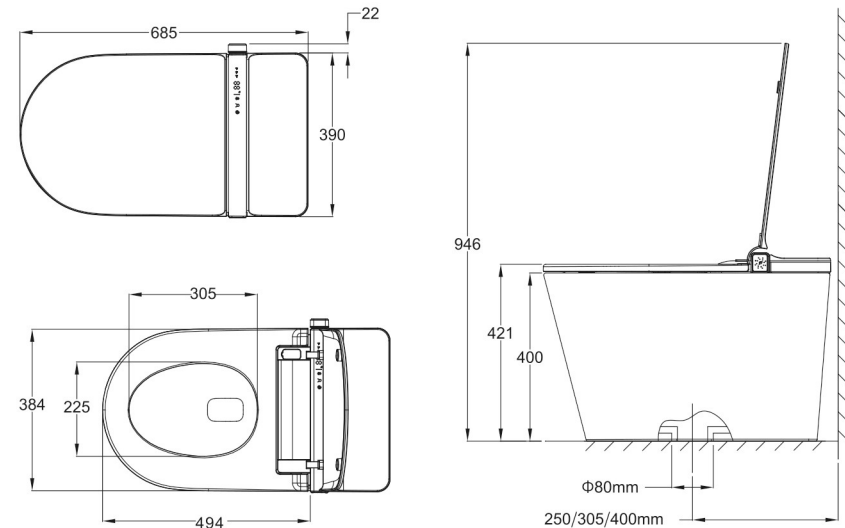

Instruction to install valve filter

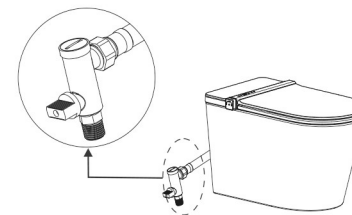

1. Connect the filter to the valve and make sure to put a flat gasket on it, otherwise water will leak;
2. Open valve to pass water, visually check is there water seepage or leakage for each pipe connection. Make sure there is no leakage before test smart toilet.

Note: For first installation, before connecting the first-level filter, it should drain for a few seconds to clear sand, gravel, dirt etc. Inside the pipe. Pay attention to the direction of the three-way valve. The picture shows opening status. (Different batches of valve, it may be slightly different. It is without further notice)

Remote Control Installation

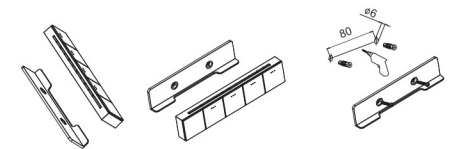

Method 1

- (Apply for smooth tiles, glass and smooth wall)
1. Choose proper installation location (Not easy to get wet, easy to takeout or operate);
 2. Clean the dust, oil stains, water droplets etc. on the installation wall;
 3. Peel off the adhesive tape on the back of the remote control bracket, align the position, and press evenly for 1-2 minutes to make it stick tightly; Placing the remote control after 12 hours;

Method 2

1. Choose proper installation location (Not easy to get wet, easy to takeout or operate);
2. Fix the bracket on the wall by installation accessories pack;
3. Place the remote control on the bracket;

6 - INSTALLATION STEP

1. Install smart toilet

1. Cut off the sewage pipe which is higher than the ground by a cutting machine.
*Keep the sewage pipe approximately 3~5mm higher than the ground.

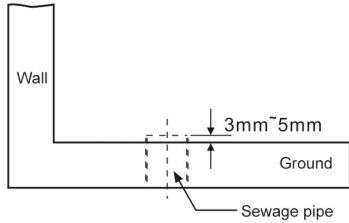

5. Draw lines on the left, right and front surface of toilet, corresponding to the center of the sewage outlet.
*The smart toilet is lay on foam board.

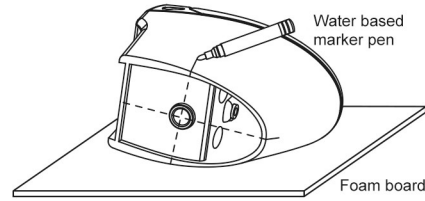

2. Disassembly the old water valve and install the new valve we provided.
*Before disassembly the valve, close the main water valve.
*The water outlet direction of the new valve is determined according to the actual situation.

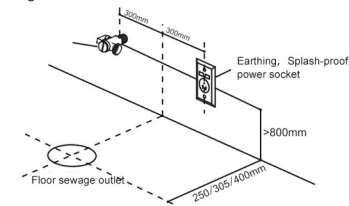

6. Install the seal ring on the drain outlet of toilet.
* Pay attention to the tighten connection.

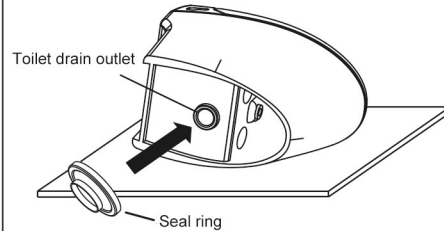

2. Clean and dry the floor
*The cleanliness and dryness of the floor will affect the firmness of product fixation.

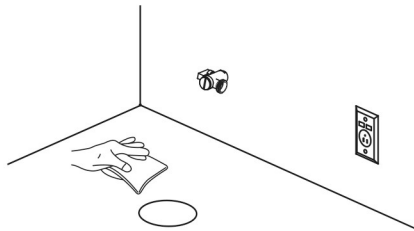

7. Lift up the toilet and place it on the ground so that the two marks coincide. Once coincide, press the toilet down to make the seal ring fully and closely contact the ground.
*Do not move the toilet or shake it left and right after the marks coincided, otherwise the sealing may be damaged, resulting in water leakage.

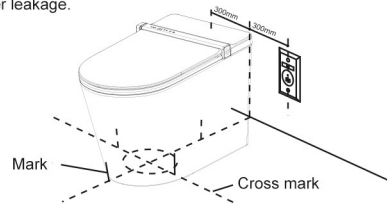

4. Use a water-based mark pen to draw a cross mark on the center line of the floor sewage outlet

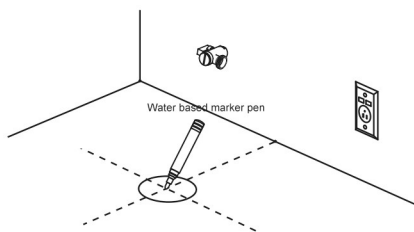

8. Connect the water inlet pipe to the filter.
*The water inlet pipe nut has a built-in sealing gasket. Be sure to install a gasket, otherwise water leakage will occur.
*If the water inlet pipe is severely bent or choked, which will seriously affect toilet flushing. The pipe is adjustable by changing the outlet direction of the valve, and ensure that the water inlet pipe is unobstructed.

Ensure that the water inlet pipe of the smart toilet is unobstructed

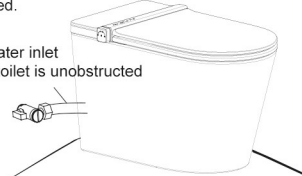

6 - INSTALLATION STEP

2. Check water supply

1. Open the water valve to the maximum as shown in the figure.

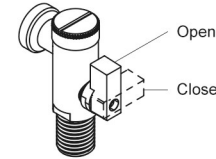

2. Confirm that there is no water leakage at each connection.
If there is water leakage, please re-tighten the nuts and install again.

3. Connect electric supply

1. Plug the power cord into an AC 220 volt socket.
2. Confirm the power is on. (The machine self-checks after powering on, and the self-check ends with a long beep)
3. Confirm the power is on.

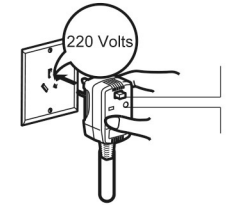

4. Check toilet's flushing effect

1. Press the stop button to start flushing. It lasts about 18 seconds per flushing.
2. For the first flush, the siphon cannot be fully formed due to lack of water in the main pipe, so it is necessary to flush several times and observe whether the toilet can form siphon every time.
If flushing is weak and there is no siphon, please check whether the water inlet pipe is unobstructed.



5. Check no water leakage from the toilet and the floor

Check no water leakage from the contact surface between toilet and floor (shaded area as the picture below).

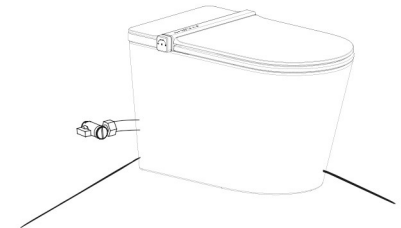

4. Fix Smart Toilet

1. After finished the function testing, fill uneven parts on the floor with filler to prevent the toilet from shaking.
2. Clean the contact surface between the toilet and the ground, keep the contact surface dry.
3. Use a caulking gun to apply a full circle of glass glue along the bottom of the toilet.
*After applying glass glue, use it after 48 hours.
*When adjusting the toilet, be careful to adjust it gently and in small increments, Never adjust it too much.

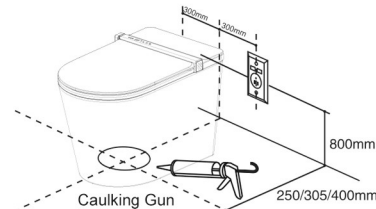

5. Trial Operation

Please follow the actual configuration and function of the product.
Operate each function key on the remote control or the knob to check whether the product function is normal.

7 - REMOTE CONTROL OPERATING

REMOTE CONTROL FOR MANUAL MODEL

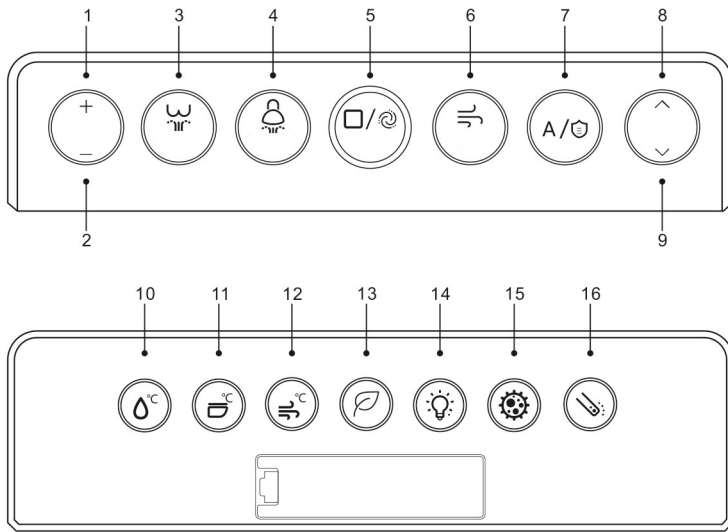

- 1 Increase washing intensity
- 2 Decrease washing intensity.
- 3 Buttock washing/One-touch washing.
- 4 Female washing/One-touch washing.
- 5 Stop/Flush/Shutdown.
- 6 Warm air drying/Air power adjustment/Five-speeds air drying.
- 7 Foam Shield/Four Seasons Temperature Sensing.
- 8 Washing position forward.
- 9 Increase washing intensity , Washing position backward.
- 10 Water temperature adjustment
- 11 Seat temperature adjustment
- 12 Air temperature adjustment
- 13 Aromatherapy/Scheduled Aromatherapy.
- 14 Night light/Ambience lights
- 15 UV sterilization
- 16 Massage washing mode/Self-cleaning.

REMOTE CONTROL FOR AUTOMATIC MODEL

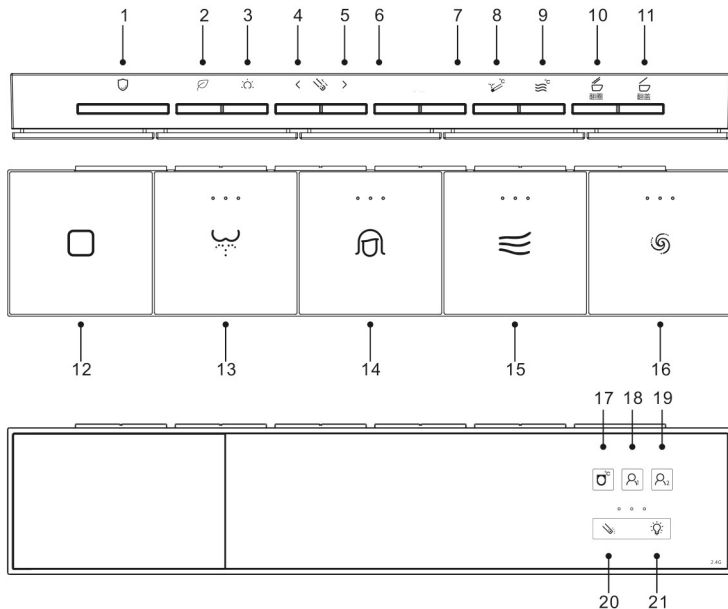

- 11 Foam Shield/Infrared Therapy
- 2 Manual aromatherapy/automatic aromatherapy/timer aromatherapy
- 3 Ambient light/Automatic ambient light
- 4 Washing position backward
- 5 Washing position forward
- 6 Increase washing intensity
- 7 Decrease washing intensity
- 8 Water temperature adjustment
- 9 Air temperature adjustment
- 10 Open/close the seat
- 11 Open/close the cover
- 12 Stop/Shutdown
- 13. Buttocks washing/One-touch washing
- 14. Female washing/One-touch washing
- 15 Drying/Air strength adjustment/Five-level foam shield/Infrared physiotherapy Air drying
- 16 Flushes
- 17 Seat temperature adjustment/Four-season temperature sensing
- 18 User memories
- 19 User memory
- 20 Massage washing/Self-cleaning/Automatic UV sterilization
- 21 Night light

REMOTE CONTROL FUNCTION INSTRUCTION

FUNCTION DESCRIPTION
Remote control code matching: Within 10 seconds after the toilet is powered on, long press the "Buttocks Wash" button, the toilet beeps once, indicating that the code is successfully matched. (% only for manual model) After the toilet is powered off for 10 seconds, long press the "Butt Wash" and "Foam Shield" buttons at the same time until the indicator light flashes. Then power on within 10 seconds, the remote control indicator light stops flashing, and the toilet beeps, indicating that the code is successfully matched. (only for automatic model)
Stop: When toilet is working, short press the "Stop" button to stop the current function (Except open the cover/seat and flushing); long press the "Stop" button to shut down (Once shutdown, lighting, display, and seat heating are turned off), all functions disabled.
Flush: When no other functions are running, short press the "flush" button to start the flushing function.
Buttocks washing/Mobile buttocks washing/One-touch washing: While seated, short press "Buttock Wash" button to start the buttock washing function; Press it again to start mobile washing. While seated, long press "Buttock Wash" button to start the one-touch washing function. Washing → Drying → end.
Female washing/Mobile washing/one-touch washing: While seated, short press the "Female Wash" button to start the female washing function; Press it again to start the mobile washing; While seated, long press the "Female Wash" button to start the one-touch washing function. Washing → Drying → end..
Massage Washing: During washing, short press the "Massage" button to turn on/off massage washing.
Warm air drying/Air strength adjustment/Five air speeds: While seated, short press the "Drying" button to start the drying function; While drying, short press the "Drying" button to select the air speed from first /second /third/fourth/fifth grades; While seated, long press the "Drying" button to start the fifth gear speed air drying.
Water Temperature Adjustment: During washing status or non Four-Season temperature sensing mode, short press the "Water Temperature" button, the water temperature will be selected between normal /low /medium /high grade.
Air temperature adjustment: During drying or non-Four-season temperature sensing mode, short press the "Air temperature" button, the air temperature will be selected between normal /low /medium /high grade.
Seat temperature adjustment: While seated or non-Four-season temperature sensing mode, short press the "Seat temperature" button, the seat temperature will be selected between normal /low /medium /high grade.
Washing position adjustment: During washing status, short press the "<" key, the washing position moves backward; short press the ">" key, The washing position moves forward (there are 5 positions grades).
Washing intensity adjustment: During washing status, short press the "+" key to increase the washing intensity; short press the "-" key to decrease the washing intensity; (there are 5 washing intensity grades).
Flip cover/seat: While not seated, press the "Flip" button to open/close the cover/seat; (only for automatic models).
Foam shield: When no functions are running, short press the "Foam Shield" button to start the foaming function; (only for models with this configuration).
Infrared therapy: While seated, long press the "Infrared therapy" button to activate the physiotherapy function; (only for models with this configuration).
UV sterilization: When not seated, long press the "Sterilization" button to start the UV sterilization function, which will automatically end in about 2 minutes or when other functions are operated or human body is sensed; (*Only for models with this configuration and the manual model) (Note: Make sure the cover is close before starting! If you want to open the cover during sterilization, please stop the sterilization function first!).
Automatic UV sterilization: Long press the "Sterilization" button to turn on/off the automatic UV sterilization function. When the automatic UV sterilization starts, the UV sterilization function will automatically turn on when the cover is close, and it will automatically end after about 2 minutes or when other functions are operated or human body is sensed; (* only for models with this configuration).
Four seasons temperature sensing mode: Long press the "Four Seasons Temperature Sensing" button to turn on/off the four seasons temperature sensing mode. Four Seasons Temperature Sensing Mode: Water temperature, air temperature, and seat temperature are automatically adjusted according to the ambient temperature. (While seated, the temperature can be adjusted manually. Return to sensing temperature mode after the function ends: the temperature cannot be adjusted when not seated.)
Manual aromatherapy/automatic aromatherapy/timer aromatherapy: Manual aromatherapy: Short press the "Aromatherapy" button to turn on or stop the aromatherapy function, and it will automatically turn off after 5 minutes. Automatic aromatherapy: Automatically start the aromatherapy when seated, and automatically turn off after 5 minutes or when leave seat. You also can turn it off. Timer aromatherapy: Long press "Aromatherapy" button, start/stop the automatic aromatherapy mode (it starts automatically every 2 hours and turns off after 10 minutes).
Ambient Light: Long press the "Ambient Light" button to switch the ambient light modes. (*Only for models equipped with remote control model SH171). Short press the "Ambient Light" button to switch the ambient light mode, long press the "Ambient Light" button to enter the automatic ambient light mode. (*Only for automatic models).
Night light: Short press the "Night Light" button to turn on/off the night light.
User Memory: While seated, long press the "User 1"/"User 2" button to memorize the corresponding water temperature, air temperature, seat temperature, water pressure, position, and air speed; short press the "User 1"/"User 2" button, adjust the function gear to the parameters set by the user; (*Only for models with this configuration).
Self-cleaning: While non-seated, short press "Self-Clean" to start automatic cleaning of the spray boom and nozzle. (Short press again to turn on/off the reciprocating movement of the boom)

8 - KNOB OPERATION INSTRUCTIONS

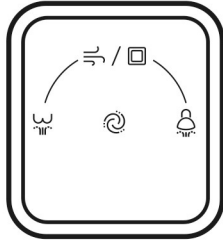

KNOB OPERATION INSTRUCTIONS	
BUTTON / FUNCTION	FUNCTION DESCRIPTION
	While seated, short counterclockwise rotate to start buttock washing function; During the washing, short counterclockwise rotate to move nozzle backwards; During the washing, long counterclockwise rotate to turn on/off the mobile washing function.
	While seated, short clockwise rotate to start female washing function; During the washing, short clockwise rotate to move nozzle backwards; During the washing, long clockwise rotate to turn on/off the mobile washing function.
	In the state of non-functional operation, short press the knob to flush; in the state of functional operation, short press to stop the current function. In non-seated state, long press to turn on the atmosphere light; in the seated state, long press to start the drying function.

OTHER FUNCTIONS DESCRIPTION	
BUTTON / FUNCTION	FUNCTION DESCRIPTION
Foot -sensitive function	(* Only for manual model) In the state of non seated, short touch the foot switch to start flushing; (* Only for automatic model) In the state of non seated, short touch the foot switch: a) Open the cover →, open the seat (less than 6 seconds) ← close the seat. b) Open the cover →, open the seat (more than 6 seconds) → close the seat and flushing. In the state of non-seated, long touch foot switch: Open the seat and cover at the same time.
Wet the toilet bowl after seated	After 30s since left the seat, once seated, the upper water flushes automatically to pre-wet the inner surface of the toilet bowl (the function is active as default).
Automatic flushing after leaving seat	The seating time is more than 6 seconds and there is no flushing before leaving the seat, automatic flushing after leaving seat. (This function is active by default).
Automatic deodorization	Once human seated, it automatically starts the foaming device, the foam outlet discharge the foam to prevent splashing and isolate odor. Foam covers the whole water surface; (this function is closed as default) (Automatic Foam Shield Starting Conditions: 1. Seating again in 30 seconds since last seat leaving. 2. The interval since the last foaming is more than 1 hour and there is no flushing.)
Automatic foam shield function	Once human seated, it automatically starts the chemical catalyst deodorization device. (This function is active by default)
Automatic Open Cover	When human body is close to the toilet, it opens the cover automatically. When there is no operation or no human body approaching, it close the cover for about 2 minutes (if the seat is opened more than 6 seconds and no flushing during this period, it closes the cover and flush) (* Only limited to this configuration model)
Flush without electric power	In the state of power outages, short press the knob to start the flushing function.
Electrolytic water sterilization	Washing system automatic electrolysis bacteria. (* Only limited to this configuration model).

9 - TROUBLESHOOTING

Items	Fault phenomenon	Fault analysis	Fault treatment
Power supply	Product does not work		Check Electric connection
		Check the leakage protector cut off or not (the indicator light of the protector does not light)	Press the reset button of the leakage protector. If it cannot operate or trips frequently, You must unplug the power plug and stop using the product, Contact the seller or after-sales service center.
		Check the product is powered on or not (No display on panel)	Long press the stop button on the remote control and the display panel will light up.
Washing function	Nozzle can't spray	Check the Seating sensor is workable or not ?	Adjust your sitting posture.
		Check the water or power is cut off or not?	Waiting for water and power to be restored.
		Check the valve is open or not?	Open valve
		Check the filter device is clogged or not?	Clean filter or replace filter
	Washing water is weak	Check the filter device is clogged or not?	Clean filter or replace filter
		Check the water pressure is at low level or not?	Adjust the water pressure grade or turn on massage washing mode.
	Nozzle stop output water	Check the washing cycle stop automatically ?	Restart the function
Check the Seating sensor is workable or not ?		Adjust your sitting position and restart the function.	
Warm air function	Air temperature is low	Check the air temperature was set at normal temperature or the low grade?	Adjust the air temperature grade.
		Check the seating sensor is workable or not ?	Adjust your sitting position and restart the function.
	No air drying	Check the drying cycle stop automatically ?	Restart the function.
Seat heating	Seat temperature is low	Check the seat temperature was set at normal temperature or the low grade ?	Adjust seat temperature.
		Check if the product has just been powered on (the product needs a short time to warm up after powered on)	Wait for product to heat up.
		The Four-season temperature sensing mode is ON and the product is on the Summer mode.	Turn off the temperature sensing mode and adjust the seat temperature grade.
Remote control	Remote control cannot work	Check the battery is discharged fully or not?	Replace battery
		Check the positive and negative poles of the battery was set correctly?	Install the battery correctly according to the markings
	Button cannot work	Check the Battery is low or not ?	Replace battery
Flushing function	Unable to flush water normally	Check the filter is clogged or not?	Clean valve's filter.
		Check the water supply pipe is broken or not?	Eliminate water supply pipes is broken.
		Check whether the interval between two flushes is more than 30 seconds (the model with tank)	The flush function is activated when the interval time between two flushes is more than 30s.
	Siphon flushing cannot work well	Check the filter is clogged or not (the model without tank)	Clean valve's filter
		Check whether the water supply pipe is bent (the model without tank)	Eliminate water supply pipes is broken.
		Check the water supply pressure is low and does not meet the product requirements (the model without tank)	Wait for the water supply is recovery or improvement of water pressure to the required range.
		Check the sewage pipe is blocked or not?	Unclog pipes

10 - MAINTENANCE

In order to ensure the normal use of the product, please clean and maintain the product regularly.

Note that when performing cleaning and maintenance, be sure to unplug the power plug from the socket, close the water supply valve and stop the water supply.

Cleaning and maintenance methods for covers, seats and other plastic parts.

- Please use a soft damp cloth to wipe the product. If the dirt is not removed in time, it will become difficult to clean. Please wipe it with water frequently. In addition, wiping with water can prevent the generation of static electricity, which can absorb dust and cause the product to become black and dirty.

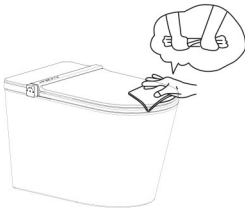

Cleaning and maintenance methods for ceramic area

- Please wipe the ceramic area of the product with a soft damp cloth, soft brush, or sponge to clean it with a neutral detergent and cold or warm water. Do not use inappropriate cleaning agents, such as: toilet cleaners, bleach, alcohol, deodorizing powder, gasoline etc.

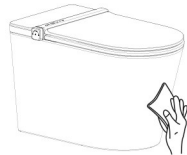

Valve filter maintenance

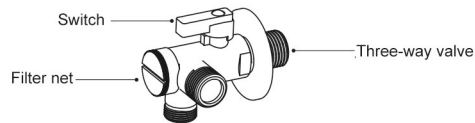

1. Turn the switch clockwise to the off position;
2. Use a flat-blade screwdriver or a coin to counterclockwise unscrew the filter net .
3. Use a brush to clean the dirt and impurities on the filter.
4. Clockwise screw the cleaning filter into the three-way valve, and check to ensure that the filter is installed in place.
5. Turn the switch counterclockwise to the fully open position.

Warning

Do not add water or detergent to the electrical part of the smart toilet or inside of the remote control. Do not get the electrical parts and power plug wet with water or detergent. Otherwise there may be a risk of electric shock and fire.

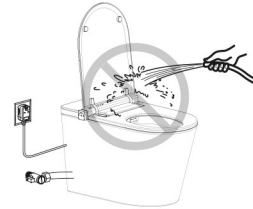

Notice

When cleaning and maintaining plastic parts, do not use unsuitable cleaners (toilet cleaner, alcohol, cresol, benzene, detergent powder, bleach, tinas, paint thinner, residential cleaner, gasoline, etc.) otherwise the plastic parts cracking may result in personal injury, electric shock, or fire.



Nozzle cleaning and maintenance methods

1. Turn the switch clockwise to the off position;
2. Use a flat-blade screwdriver or a coin to counterclockwise unscrew the filter .
3. Use a brush to clean the dirt and impurities on the filter.
4. Screw the clean filter clockwise into the three-way valve, and check to ensure that the filter is installed in place.
5. Turn the switch counterclockwise to the fully open position.

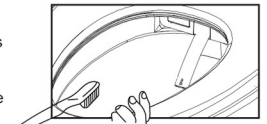

Aromatherapy tablet replacement and Foam liquid addition

Replacement of scented tablets

1. Press the aromatherapy box with your finger, the aromatherapy box will pop out, and remove the old one.
2. Put 2 pieces of aromatherapy into the aromatherapy box (Diameter less than 20mm),
3. Push the box into the toilet.

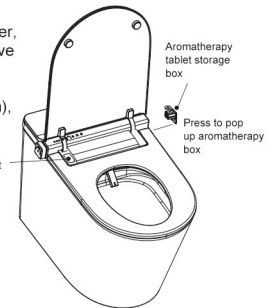

Foam liquid addition

1. Open the cover of the liquid filling port
2. Aim at the port and slowly pour the foam liquid into the port (Maximum 450ml)
3. Close the rubber cap .

11 - PRODUCT SPECIFICATIONS

Rated voltage	AC220V/50HZ
Rated power	1050W
Maximum input	1700W
Use ambient	3°C~40°C
Water supply temperature	4°C~35°C
Waterproof level	IPX4
Nominal water consumption	5.0L
Nominal water consumption	Clean the toilet 0.03Mpa~0.75Mpa (model with tank) 0.15Mpa~0.75Mpa (model without tank)
	Body washing 0.08Mpa~0.75Mpa
Body washing	Heating and safety Instant heating 1600W, Over temperature and flame retardant
	Buttock washing 450ml~650ml
	Female washing 450ml~650ml
	One-touch washing Wash, Flush, Dry
	Mobile washing Swing width is about
	Bubble massage Pulse (model without tank)
	Water pressure 3 grades settings, 450ml~650ml
	Position 5 grades settings
	Temperature adjustment Normal temperature / low grade / mid grade / high grade, normal temperature ~ 41°C
Seat heating	Heating and safety About 50W, over-temperature and flame retardant protection
	Surface temperature Normal temperature / low grade / mid grade / high grade, normal temperature ~ 41°C
Warm air drying	Heating and safety About 250W, over-temperature and flame retardant protection
	Warm air temperature Normal temperature/low grade/medium grade/high grade, normal temperature 55°C
	Air speed adjustment Five-grades adjustment
Cover/seat open and close	Automatic open and close Microwave induction, motor drive; can be turned on/off
	Manual open and close Hydraulic descent device
Comfort assistance	Deodorize Chemical catalyst
	Aromatherapy Aromatherapy table
	Foam shield Foam is for odor-isolation and splashing-proof. The capacity of container is 450ml it can be opened/closed.
	Self-cleaning Cleaning before use /Maintenance cleaning
	Soft night light White, can be turned on/off
	Ambient Light Multiple modes optional
	HD digital display Status, Temperature, Error display
	Moistening the bowl after seated Can be turned on/off
	Flush after leaving seat Can be turned on/off
	Flush during power 12~16V battery pack (model with tank)/9V battery pack (model without tank)
	Infrared therapy It lasts about 3 minutes and can end automatically
	Electrolyzed water sterilization Self-cleaning water sterilization
	UV sterilization It lasts about 2 minutes and can end automatically
	Four seasons temperature sensing Automatic temperature adjustment mode, can be turned on/off
	User memory User mode, memory water temperature, air temperature, seat temperature, water pressure, position, air speed
Convenient control	remote control 2.4G, Powered by two AA batteries
	Knob Washing/Drying/Flushing/Function settings
	Foot touching button Open and close /Flushing
Leakage Protector	Maximum load 10A, leakage protection current ≥10mA; power cord length approximately 1.5m
Product Size	685x390x436 (mm)
Product Net Weight	Cover unit is 7KG / Whole set toilet is 42KG

12 - INSTRUCTIONS ON ENVIRONMENTAL PROTECTION, ENERGY EFFICIENCY AND WATER EFFICIENCY

Smart Toilet Energy Efficiency and Water Efficiency levels Instructions

The energy and water efficiency levels of smart toilets are divided into three levels, the 3rd level is the lowest energy and water efficiency. The unit cycle energy consumption, average washing water consumption and average flushing water consumption of each level should comply with the provisions of Table 1.

Table 1 Smart toilet energy efficiency and water efficiency level indicators

Smart toilet energy efficiency and water efficiency levels			Level 1	Level 2	Level 3
Energy efficiency level index	Energy consumption per cycle/(kw.h)	With seat heating function	≤0.030	≤0.040	≤0.060
		Without seat heating function	≤0.010	≤0.020	≤0.030
Water efficiency level index	Average water consumption for washing/L		≤0.30	≤0.50	≤0.70
	*Average water consumption for flushing/L		Comply with the requirements of level 3 indicators in GB 25502	Comply with the requirements of level 3 indicators in GB 25502	Comply with the requirements of level 3 indicators in GB 25502
	*Full water consumption for dual flushing/L		Comply with the requirements of level 3 indicators in GB 25502	Comply with the requirements of level 3 indicators in GB 25502	Comply with the requirements of level 3 indicators in GB 25502
Note 1: "*" Applies to 70% of all-in-one smart toilets.					
Note 2: For each water efficiency level, the average half-flush water consumption of a dual-flush toilet shall not be more than 70% of the maximum water consumption limit for full flushing.					

The energy efficiency and water efficiency level of this product is Level 2.

The names and contents of hazardous substances in the product.

In accordance with the relevant regulations and requirements of the "Administrative Measures for the Restriction of the Use of Hazardous Substances in Electrical and Electronic Products" of the People's Republic of China, the following format including the names of electronic product parts and hazardous substances is provided.

Part Name	Harmful Substance					
	Pb	Hg	Cd	Cr(VI)	PBB	PBDE
Control device	X	○	○	○	○	○
Remote control	X	○	○	○	○	○
Wires and connectors	○	○	○	○	○	○
Housing components	○	○	○	○	○	○
Thermal device	X	○	○	○	○	○
Drying device	X	○	○	○	○	○
Washing device	X	○	○	○	○	○
Waterway components	X	○	○	○	○	○
Labels	○	○	○	○	○	○
<p>This form is prepared in accordance with the provisions of SJ/T 11364. 0: Indicates that the content of the hazardous substance in all homogeneous materials of this part is below the limit required by the GB/T 26572 standard. X: Indicates that the content of the hazardous substance in at least one homogeneous material of the component exceeds the limit requirements stipulated in the GB/T 26572 standard. The components marked with the above "X" currently have no alternative technologies and components, and they comply with the national "Electrical Appliances" Regulatory requirements of the Measures for the Administration of Restrictions on the Use of Hazardous Substances in Electronic Products.</p>						

Under the current technical level, the content of harmful substances used is controlled to the lowest level. The Company will continue its efforts to reduce the use of these substances through improved technologies.

The "environmental protection use period" of this product is 10 years. This is shown in the figure on the right. The environmentally friendly use period of replaceable parts may differ from the environmentally friendly use period of the product. Only use this product under normal conditions as described in this manual.

The "environmentally friendly use period" is only valid.

